



KIP 2300

HIGH PRODUCTION CCD SCAN SYSTEM



KIP 2300 CCD SCANNING SYSTEM

High Production Scan System

The new KIP 2300 high productivity scanner sets a uniquely high standard for speed, quality and flexibility in a digital image capture system.

Best in class productivity is achieved by a combination of advanced camera based image capture and Super-Speed USB3s Technology for high speed data throughput with no system pauses or slow downs.

Outstanding image quality is delivered through the innovative use of bright white LED light sources for illumination and 600 x 600 dpi image capture resolution.

The KIP 2300 is a high speed scan solution that provides world-class workflow flexibility through its ability to scan face up or face down and scan thick mounted originals and loose sheets of paper from a single unit.

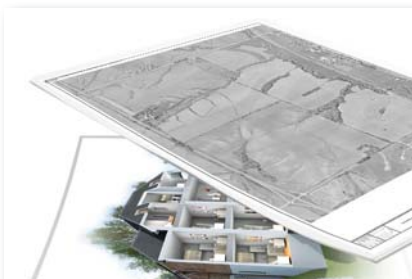

Versatile Camera Imaging

The KIP 2300 Color Scanner Solution can support both monochrome and color scan-to-file and copy to satisfy most application needs. When scanning to file, users have advanced software controls over image quality; when copying.

The KIP 2300 scanner is powerful, with image capture speeds from 5 ips to 12 ips in monochrome (dependent on dpi) and 2 to 6 ips in color. The image capture area is up to 36 in. wide, yet originals up to 42 in. wide may be fed through the scanner.

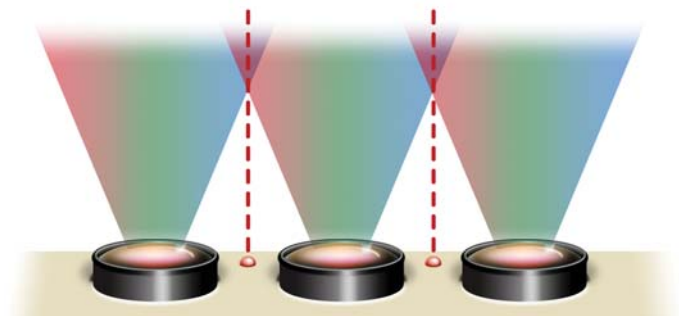
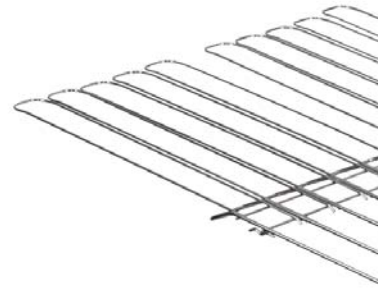

Three independent imaging cameras with an advanced laser alignment system and self-calibrating diagnostics provide an extraordinary level of quality.



Flexible Scan System

600 dpi optical resolutions is the key to the KIP 2300 Color Scanner's outstanding imaging capabilities. In addition, the KIP 2300 Color Scanner takes full advantage of patented (Real Time Thresholding) and self-calibrating imaging cameras to ensure high quality results.

To optimize image size for intended use, users can select custom resolutions, for website, PC monitor displays and for offset press work.

Super-Speed USB3 Technology

The technology used in Super-Speed scanning provides an image data transfer rate of 5 GB per second, ensuring high productivity for the most complex full color documents. Originals are imaged at maximum speed with no scanning slowdowns or pauses, as found in competitive scanning systems. Super-Speed scanning delivers full color, high speed imaging for the most demanding production environments.

Super-Speed USB3 TECHNOLOGY

- **Faster than any other competing image transfer technology**
- **10 times faster than USB 2.0!**
- **Scan documents at full speed and full resolution**
- **No scanning pauses or slow downs**

KIP COLOR EXPRESS



KIP Color Express

KIP Color Express software provides features to include copy, scan & file to print, professional ICC color management, image editing capabilities, paneling of images for outdoor graphics, nesting of images for optimum media usage and much more.

- Supports a full range of color file formats
- Create, edit & save image quality filters
- Integrates with single or multiple KIP System K printers
- Scan to email, USB drives, mailboxes or network
- Professional grade image enhancement options
- Expert mode printing features
- Black point and white point adjustments
- Sharpness and scan speed control
- Image editor with deskew and cropping

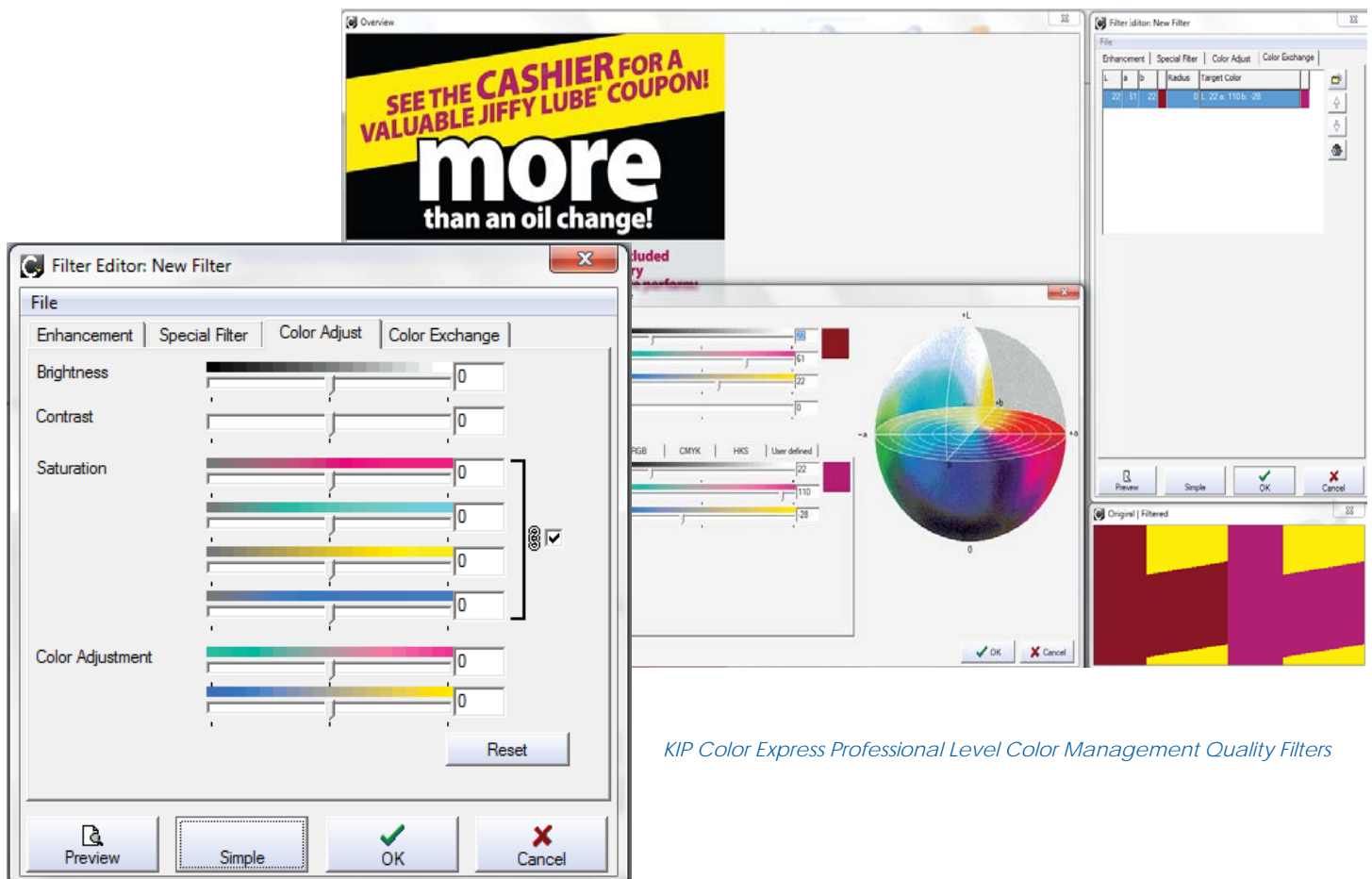

KIP Color Express Professional Level Color Management Quality Filters



Copy, Print & Scan



Professional Image Editor

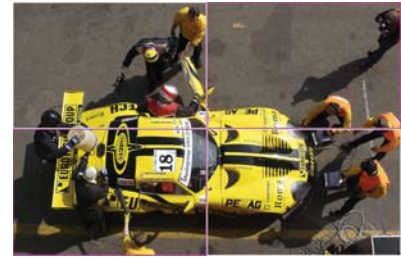

Copy & Print Paneling

KIP Color Express Features	B&W	Color
Single and Collated Sets Copying	•	•
Mixed Mono and Color Copying	•	•
Scale By Factor, Page Size, Auto	•	•
Image Preview	•	•
Auto Image Deskew	•	•
Area of Interest Reduce/Enlarge	•	•
Auto Start for Fast Document Feeding	•	•
Copy to all KIP System K printers	•	•
Concurrent Copy and Print	•	•
Scan to File & Copy In Parallel	•	•
Professional Grade Copy Filter Editor and Preview	•	•
KIP Cost Center Application Integration	•	•
KIP Track System	•	•
Scan Features		
Auto Detect Original Size	•	•
Scan Area of Interest / Scan to Specific Size	•	•
Wide Variety of Formats	•	•
Scan to Email (Full Image or Area of Interest)	•	•
Mono / Grayscale / Color Scanning	•	•
Scan to Multipage PDF and TIF	•	•
Scan Image Compression (Variable)	•	•
Graphics Viewer/Editor for Despeckle/Deskew	•	•
Auto Increment of File Name	•	•
File to Print Features		
Print Single or Multiple Files to KIP	•	•
Paneling	•	•
KIP Printer Linearizations	•	•
Spot Color Exchange	•	•
Nesting (Step and Repeat)	•	•
On Screen Softproof Capability	•	•
Copy Features		
Color Adjustment		•
Paneling	•	•
Roll Preview	•	•
Gamut Warning and On Screen Softproof	•	•

KIP Color Express Features	B&W	Color
Copy Features		
Multicopy Nesting	•	•
Set Black and White Point at Start of Set	•	•
Media Calibration Wizard	•	•
Job Editor to Mix Copy, Scan and File Images	•	•
Reprint	•	•
Nesting (Step and Repeat)	•	•
Printer/Scanner Closed Loop Calibration	•	•
Unlimited Presets/Templates	•	•
Professional Copy Filter Editor		
Adjust Scan/Copy Resolution	•	•
Adaptive Black Point By Auto or User Selection	•	•
Adaptive White Point By Auto or User Selection	•	•
Black Enhancement	•	•
Background Removal	•	•
Included Printer Drivers for 1 KIP, 2 Inkjets	•	•
Additional KIP and Inkjet Drivers	Optional	Optional
Scan Features		
Scan to File	•	•
Scan to File - File formats	All Types	All Types
Color Adjustment		•
Grayscale Adjustment	•	•
Background Processing	•	•
Import Color Profiles		•
Scan at Faster Speeds at Lower DPI	•	•
Control Scanner Speed Independent of DPI	•	•
Supports PDF Security Protocols	•	•
Unlimited Presets/Templates	•	•
Professional Scan Filter Editor and Preview	•	•
Adjust Scan/Copy Resolution	•	•
Adaptive Black Point By Auto or User Selection	•	•
Adaptive White Point By Auto or User Selection	•	•
Scan B&W Images Using Color Data	•	•
Twain Support	•	•
Graphics Editor and Preview	•	•
Despeckle and Hole Fill	•	

• = New/Enhanced available in latest version

KIP 2300 SPACE REQUIREMENTS

KIP 2300 Scanning System Space Requirements

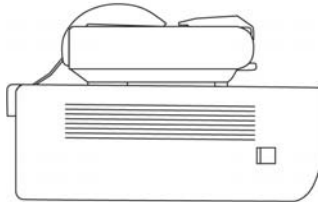

KIP 2300 Side View

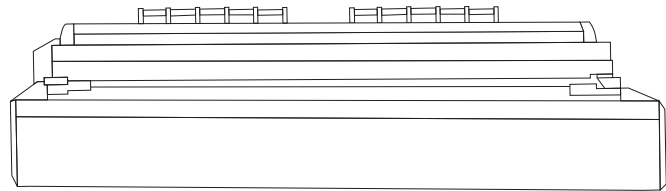

KIP 2300 Front View

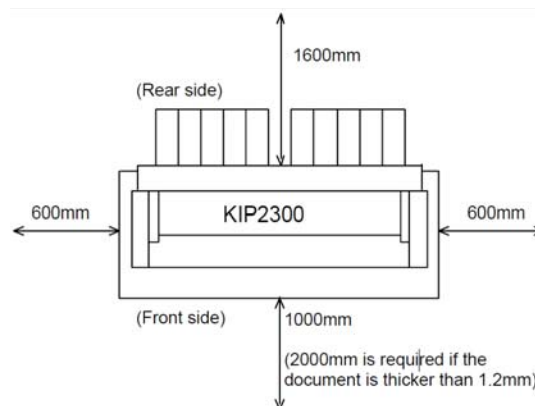

KIP 2300 Top View

KIP 2300 SPECIFICATIONS

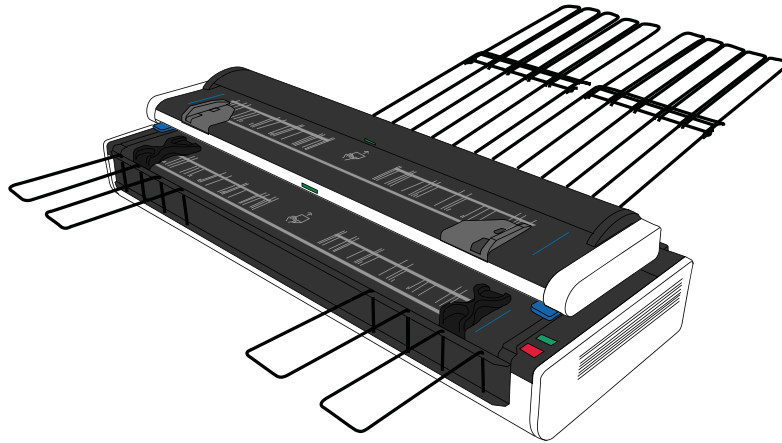

General	
Scanner Type	C.C.D. with Super-Speed USB3 Technology and KIP RTT Technology
Scan Resolution	600 x 600 dpi optical resolution
Scan Speed	Up to 12 ips / 305 mm per second (B&W) Up to 6 ips / 152 mm per second (Color)
Scan Formats	TIFF, Multipage TIFF, PDF, PDF-A, Multipage PDF, DWF, Multipage DWF, JPEG, CALS
Scan Destination	Local USB (Removable Media), Unlimited IPS Mailboxes (Local), Unlimited FTP, Unlimited SMB
Original Size Width/Length	Originals Up to 42" - 36" / 1,066 mm - 914 mm Scan width
Original Thickness	Up to .6" / 16 mm Automatic thickness detection
Original Face Up/Face Down	Both - Dual Original Feed Tables
Interface	USB 3.0, Super-Speed USB3 Technology (5 GB per sec data transfer)
Dimensions	55" W x 21" D x 11" H / 1,399 mm W, 480 mm D, 310 mm H
Weight	160 lbs / 73 kg
Electrical	100-240V AC 50/60 Hz
Power Consumption	< 120 W
Minimum PC Requirements (NOT INCLUDED WITH SCANNER)	Quad Core Processor (such as an Intel i5 or higher) Windows 7 / 8 / 10 (32 or 64 bit version) 8GB RAM with 64 bit or 3GB RAM 32 bit 1 TB Hard Drive 1 Gig RJ45 LAN Port DVD/CD Optical Drive One USB 3.0 Port (scanner connection) 20" Flat panel monitor (with VESA - 75 or 100 mount patterns for use with a KIP scanner stand) USB keyboard and mouse



USA: Phone: (800) 252.6793 | Email: info@kip.com **CANADA:** Phone: (800) 653.7552 | Email: info@kipcanada.com

KIP is a registered trademark of the KIP Group. All other product names mentioned herein are trademarks of their respective companies. All product features and specifications are subject to change without notice. Complete product specifications are available upon request. © 2017